

COMER

LED CAMERA LIGHT

CM-LBPS Series

CM-LED Series

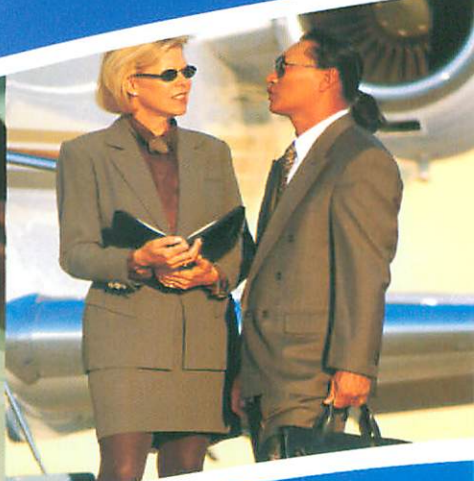
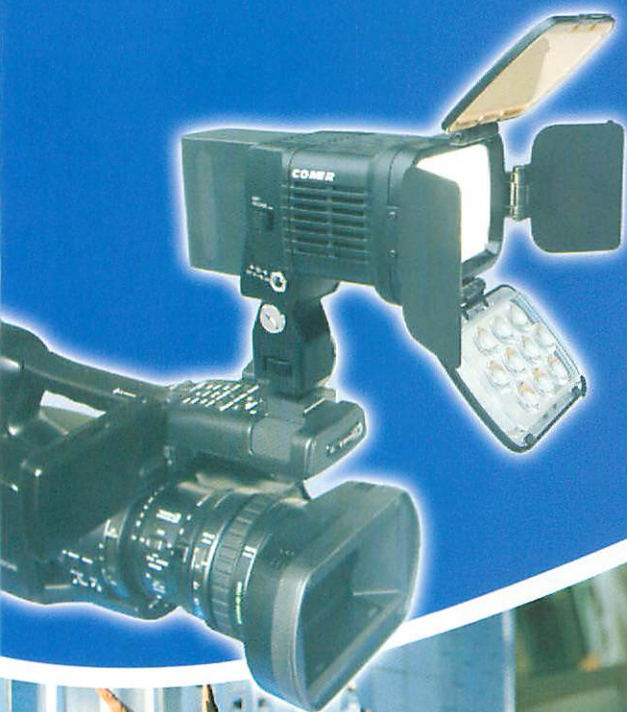

LED Camera Light

Diffuser

(softens the light, reduces the color temperature)

Penetrative Lens

(softens the light, protects the lamp tube)



Protection plate
(protects the optical lens)

Condenser Lens
(adjust to high beam, illuminance can be doubled by using the condenser lens)

Features

1. Our Camera Lights use a world famous high-brightness white LED as its lens light source.
2. The irradiation range is wide with homogeneous light distribution.
3. Color temperature can be adjusted for 4500K or 3200K by the diffuser according to the actual situation.
4. The Camera Light provides high-intensity illumination with higher luminous efficiency: 1200lux or 1800lux(1m).
5. The brightness can be adjusted.
6. The Camera Light can be adjusted for high beam or low beam by the condenser lens according to the actual needs.
7. The Camera Light can have a long life time of about 10,000 hours.
8. The power consumption of 18W is equal to the illumination of normal light of 80 W.
9. The Camera Light is easy to be installed and operated.

The installation methods

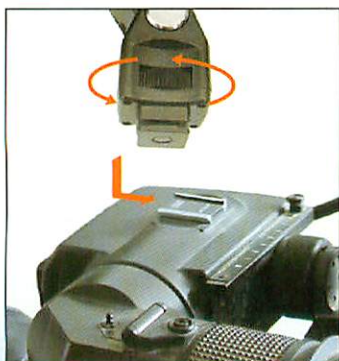

Method 1: Cold Shoe

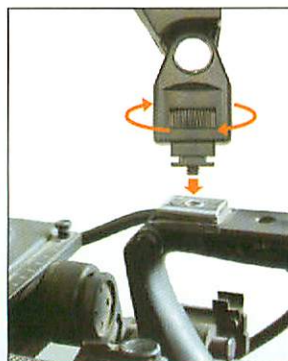

Method 2: Bolt

Four kinds of irradiation

(Take the CM-LBPS1200 as the example)

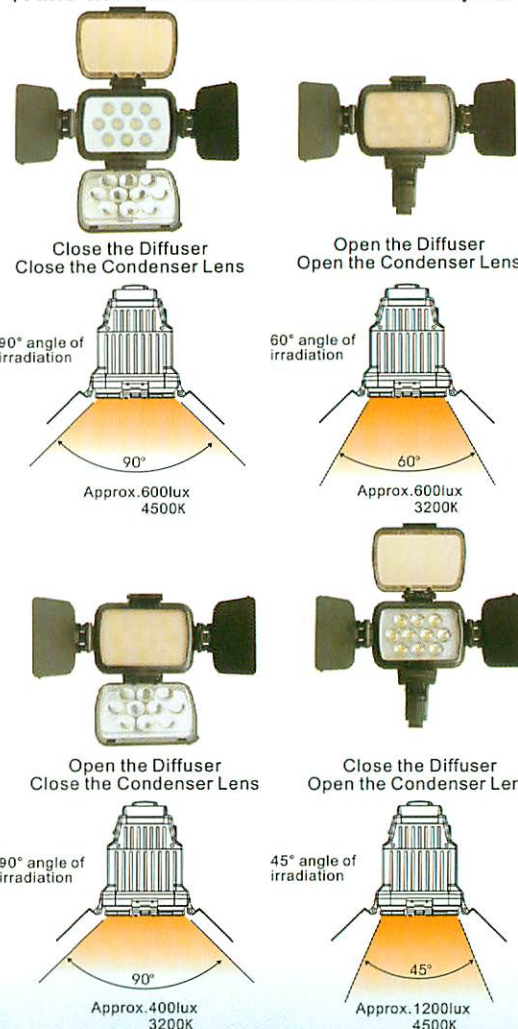

The test condition: Put the BRIGHT dial to its MAX with a distance of 1m and temperature of 25°C and have good condition for ventilation.

Seven operation methods of using the CM-LBPS series:

1: Hold the Video Camera (powered by portable battery pack)

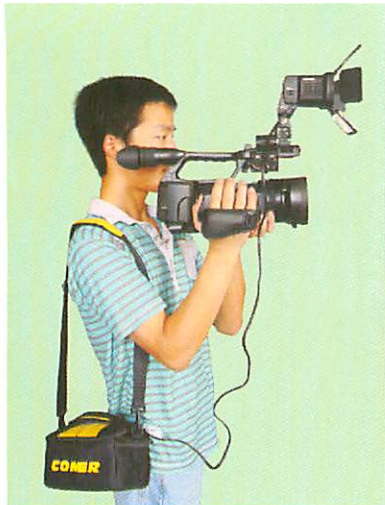

2: Hold the Video Camera on shoulder (powered by DV battery pack)



3: Hold the Video Camera on shoulder (powered by portable battery pack)



4: Hold the Video Camera (powered by DV battery pack)

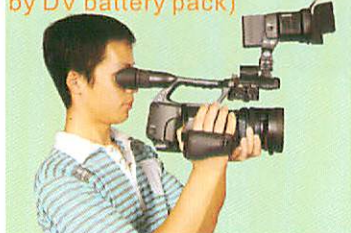

5: Hold the Video Camera on shoulder (share the battery pack with the Video Camera)



6: Hold the Camera Light (powered by DV battery pack)

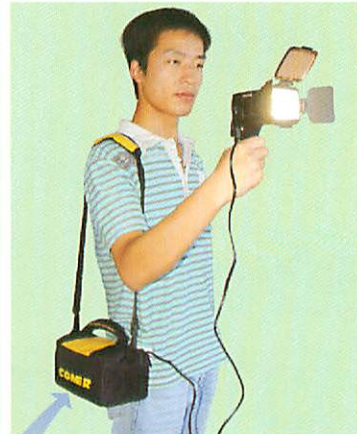

7: Hold the Camera Light (powered by portable battery pack)



Power Switch and the Bright dial



Diffuser

Battery Interface

Protection Plate

Condenser Lens



Battery Release Button



External Power Receptacle
Connect with the battery of DC6V ~17V using the DC-Adapter line

Angle Adjusting

CM-LED1200/CM-LED1800

Operation methods of using the CM-LED series:

The camera and the Camera Light share with one battery



B type power plug

The detailed feature

1. Our Camera Lights use a world famous high-brightness white LED as its lens light source.
2. The Camera Light is energy-Saving and environmental-friendly with the maximum power consumption of approx.18W for CM-LBPS1200/CM-LED1200 and approx. 20W for CM-LBPS1800/CM-LED1800.
3. The irradiation range is wide with homogeneous light distribution(90° angle for brand light and 45° angle for spotlight).
- 4.The Camera Light provides high-intensity illumination with higher luminous efficiency:CM-LBPS1200/CM-LED1200 can reach 1200lux(1m),CM-LBPS1800/CM-LED1800 can reach 1800lux(1m).
5. Color temperature can be adjusted for 4500K or 3200K by the diffuser according to the actual situation.
6. The brightness can be adjusted:10%~100%.
7. The Camera Light can be adjusted for high beam or low beam by the condenser lens according to the actual needs.
8. The Camera Light has a long life time of about 10,000 hours with excellent impact-resistance and weather resistance qualities, and so requires hardly any maintenance or replacement.
9. The Camera Light is easy to be installed and operated .

Specifications

MODEL	CM-LBPS1200	CM-LBPS1800	CM-LED1200	CM-LED1800
Input	DC 6V~17V	DC 6V~17V	DC 6V~17V	DC 6V~17V
Maximum Power Consumption	Approx.18W	Approx.20W	Approx.18W	Approx.20W
Maximum Luminosity	1200lux(1m)	1800lux(1m)	1200lux(1m)	1800lux(1m)
Lighting Distance	1200 lux(1m)	1800lux(1m)	1200 lux(1m)	1800lux(1m)
	133lux(3m)	200lux(3m)	133lux(3m)	200lux(3m)
	48lux(5m)	72 lux(5m)	48lux(5m)	72 lux(5m)
	19lux(8m)	28 lux(8m)	19lux(8m)	28 lux(8m)
	12 lux(10m)	18 lux(10m)	12 lux(10m)	18 lux(10m)
Color Temperature	4500K/3200K	4500K/3200K	4500K/3200K	4500K/3200K
Operating Temperature	0~40°C	0~40°C	0~40°C	0~40°C
Storing Temperature	-20~+60°C	-20~+60°C	-20~+60°C	-20~+60°C
Weight	420g (only for the Light)	420g (only for the Light)	450g	450g
Dimension	Approx.108×150×129 (mm)	Approx.108×150×129 (mm)	Approx.108×150×113 (mm)	Approx.108×150×113 (mm)
Interface Type	Battery pack of NP-F970/NP-F770 or B type power plug (DC6V~17V)		B type power plug (DC6V~17V)	
Illuminance Duration	Approx.160 min (NP-F970) Approx.100 min (NP-F770)	Approx.140 min (NP-F970) Approx.90 min (NP-F770)	Approx.420 min (130wh/14.8V)	Approx.380 min (130wh/14.8V)

Note :Illuminance duration just for using full-charged battery,turn the BRIGHT dial to its MAX,and in the ambient temperature of 25°C.

Accessories



External power adapter
line(0.55m)
(Just for CM-LBPS Series)

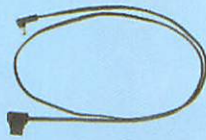

External power adapter
line(1.20m)
(Just for CM-LBPS Series)



Portable
Camera Light bag

Measure Chart

CM-LBPS Series

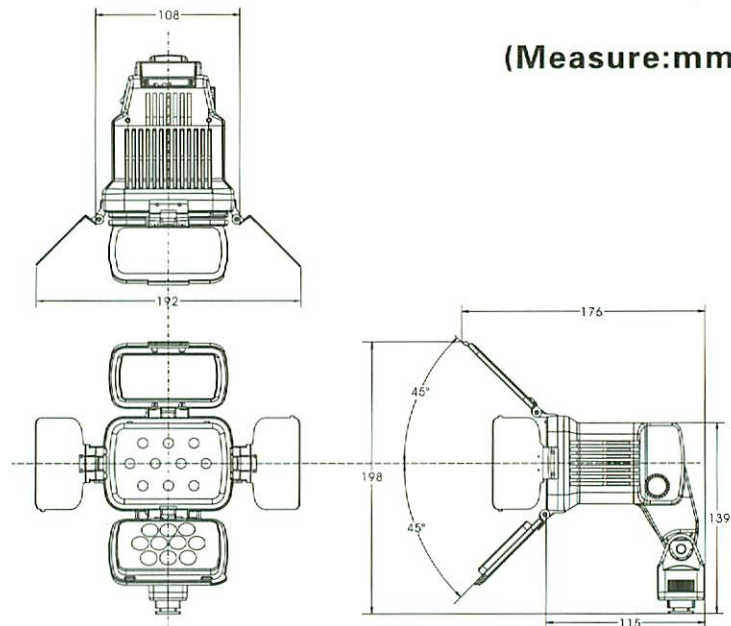

CM-LED Series

